

## PRODUCT DESCRIPTION

Standard fastener for light-weight fixtures. It is inserted into the extrusion through a pre-drilled hole. The fastener is equipped with a longitudinal hole for the FI-3 ROD

Fill empty fields

Product nr.  
Fixture type  
Company  
Job name  
Date



## TECHNICAL SPECIFICATION

## TECHNICAL DRAWING

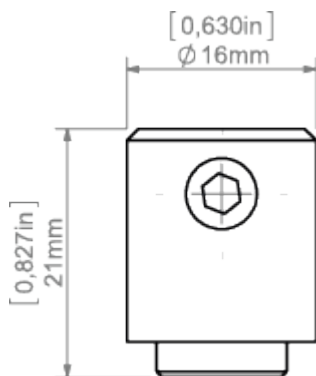

RELATED PROFILES

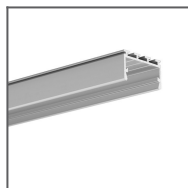

GIZA-LL profile  
Ref: C0758

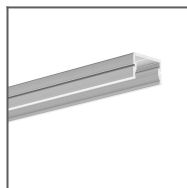

SILER Profile  
Ref: B9325

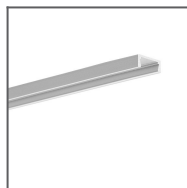

MICRO-ALU Profile  
Ref: B1888

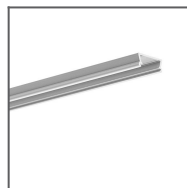

TAMI Profile  
Ref: B5390

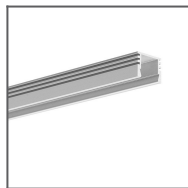

PDS-4-ALU Profile  
Ref: B1718



REGULOR Profile  
Ref: B468+43

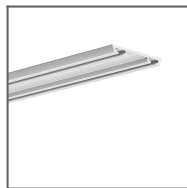

TEST-36 Profile  
Ref: B6639

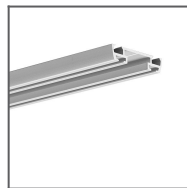

TEST-74 Profile  
Ref: W4507

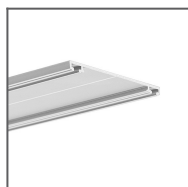

TETRA-43 Profile  
Ref: W4476

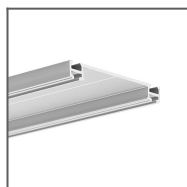

TETRA-78 Profile  
Ref: W4508

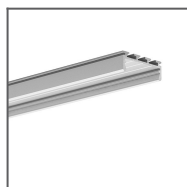

GIZA Profile  
Ref: B5556

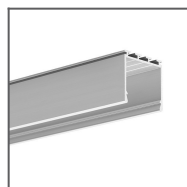

LIPOD Profile  
Ref: B5554

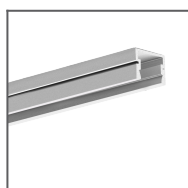

PDS-4-PLUS  
Profile  
Ref: C1263

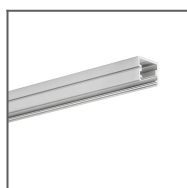

TAPO Profile  
Ref: C1919

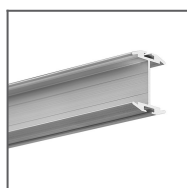

GIZA-DUO-LL  
Profile  
Ref: C2162

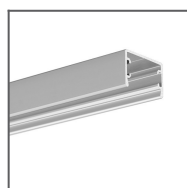

GLAZA-LL Profile  
Ref: C2627

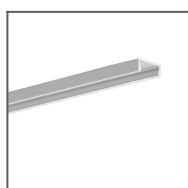

MICRO-PLUS  
Profile  
Ref: C2966

## RELATED PRODUCTS

## ACCESSORIES



100 PUSZ brass  
chrome Rod 1 m  
Ref: 42518

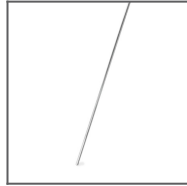

Brass chrome FI-3  
Rod 1m  
Ref: 42501

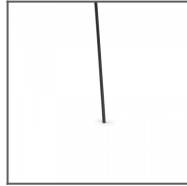

FI-3-ALU Rod  
black 1 m  
Ref: 42527

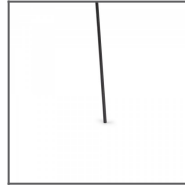

FI-3-ALU Rod  
black 2 m  
Ref: 42529



FI-3-ALU Rod  
silver 1 m  
Ref: 42526



FI-3-ALU Rod  
silver 2 m  
Ref: 42528

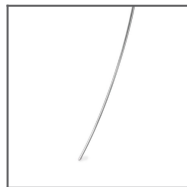

Steel FI-3 Rod 53  
cm  
Ref: 1528

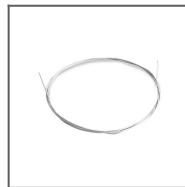

Steel wire FI-1 1m  
Ref: 1397