

PRODUCT DESCRIPTION

Standard conductive fastener for light-weight fixtures. The extrusion is inserted into the MOUNTING BRACKET for the 45 - ALU profile. Power is supplied through a hole inside the fastener which is equipped with a longitudinal hole for the FI-3 ROD, which acts as a power conductor

Fill empty fields

Product nr.

Fixture type

Company

Job name

Date

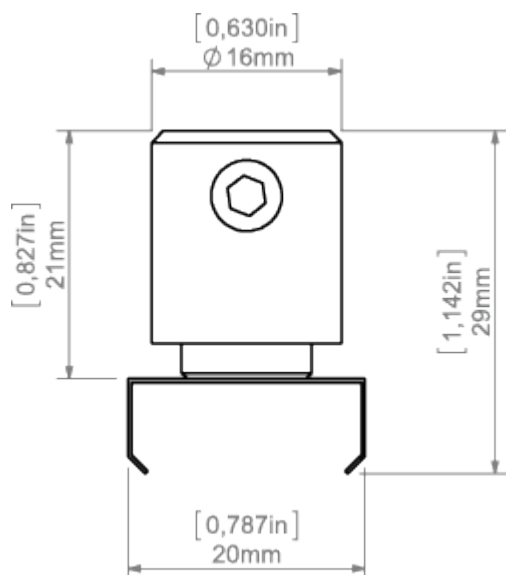
**TECHNICAL SPECIFICATION****TECHNICAL DRAWING**

RELATED PROFILES

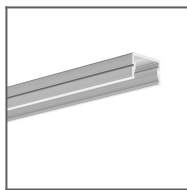

SILER Profile
Ref: B9325

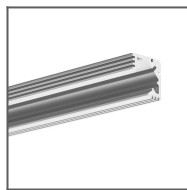

45-ALU Profile
Ref: B4023

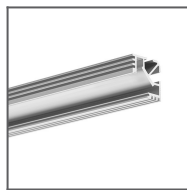

TAN-C5 Profile
Ref: B5391

RELATED PRODUCTS

ACCESSORIES



100 PUSZ brass
chrome Rod 1 m
Ref: 42518



Brass chrome FI-3
Rod 1m
Ref: 42501

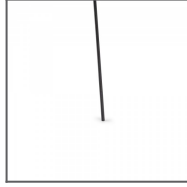

FI-3-ALU Rod
black 1 m
Ref: 42527

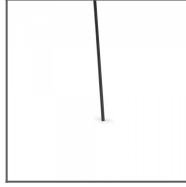

FI-3-ALU Rod
black 2 m
Ref: 42529



FI-3-ALU Rod
silver 1 m
Ref: 42526



FI-3-ALU Rod
silver 2 m
Ref: 42528

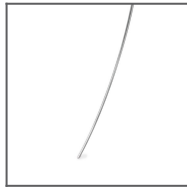

Steel FI-3 Rod 53
cm
Ref: 1528

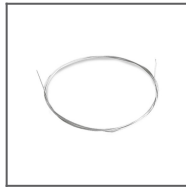

Steel wire FI-1 1m
Ref: 1397