

## PRODUCT DESCRIPTION

Standard conductive fastener for light-weight fixtures. The extrusion is inserted into the MOUNTING BRACKET for the 45 - ALU profile. Power is supplied outside the fastener to a power connector. One current pole is powered from one fastener that is equipped with a longitudinal hole for the FI-3 ROD, which acts as a power conductor

Fill empty fields

Product nr.

Fixture type

Company

Job name

Date



## TECHNICAL SPECIFICATION

## TECHNICAL DRAWING

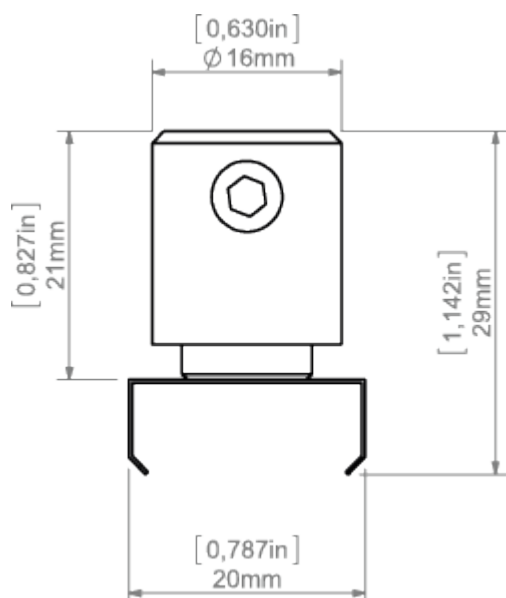

**RELATED PROFILES**

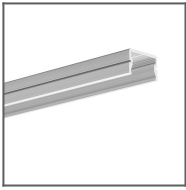

SILER Profile  
Ref: B9325

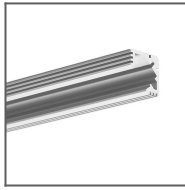

45-ALU Profile  
Ref: B4023

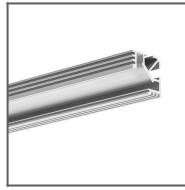

TAN-C5 Profile  
Ref: B5391

**RELATED PRODUCTS**

**ACCESSORIES**



100 PUSZ brass  
chrome Rod 1 m  
Ref: 42518

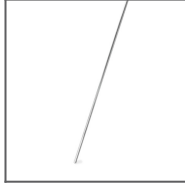

Brass chrome FI-3  
Rod 1m  
Ref: 42501

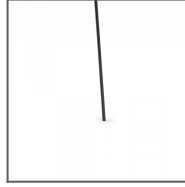

FI-3-ALU Rod  
black 1 m  
Ref: 42527

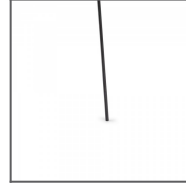

FI-3-ALU Rod  
black 2 m  
Ref: 42529



FI-3-ALU Rod  
silver 1 m  
Ref: 42526



FI-3-ALU Rod  
silver 2 m  
Ref: 42528

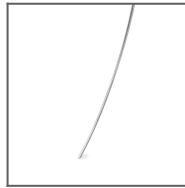

Steel FI-3 Rod 53  
cm  
Ref: 1528

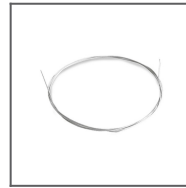

Steel wire FI-1 1m  
Ref: 1397