

PRODUCT DESCRIPTION

- High wear resistance
- Does not corrode
- Simple assembly
- Finishes the profile aesthetically

Fill empty fields



Product nr.

Fixture type

Company

Job name

Date

TECHNICAL SPECIFICATION

Material	ABS, metal components
Colour	grey

TECHNICAL DRAWING

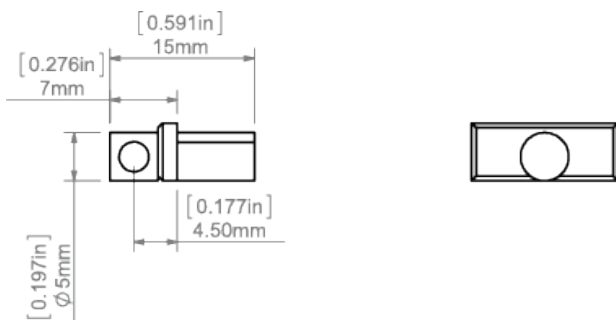

RELATED PROFILES

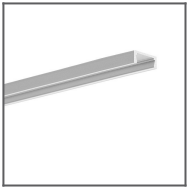

MICRO-ALU Profile
Ref: B1888

RELATED PRODUCTS

ACCESSORIES



100 PUSZ brass chrome Rod 1 m
Ref: 42518

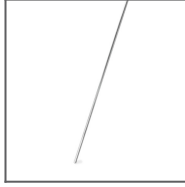

Brass chrome FI-3 Rod 1m
Ref: 42501

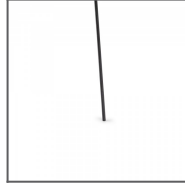

FI-3-ALU Rod black 1 m
Ref: 42527

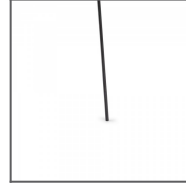

FI-3-ALU Rod black 2 m
Ref: 42529



FI-3-ALU Rod silver 1 m
Ref: 42526



FI-3-ALU Rod silver 2 m
Ref: 42528

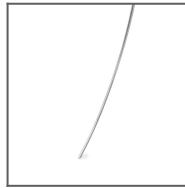

Steel FI-3 Rod 53 cm
Ref: 1528

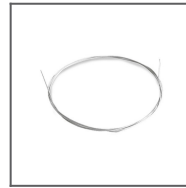

Steel cable with Cu FI 0.95 mm core
Ref: 70240

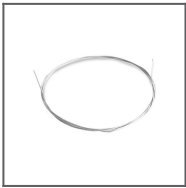

Steel wire FI-1 1m
Ref: 1397