

Linear Specification

BE2513

—ALS-L series



【Feature】

- Profile material: AL6063-T5
- Optical design: Unique optical structure design, uniform light without shadow
- Appearance color: black, white, silver
- ERP level: F
- Luminaire efficiency (LOR):
- Product certification: ROHS, Reach
- Application: indoor
- Installation method: embedding
- Warranty: 5 years
- IP grade: IP20

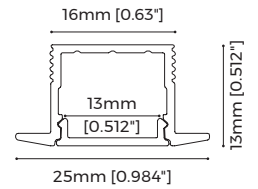
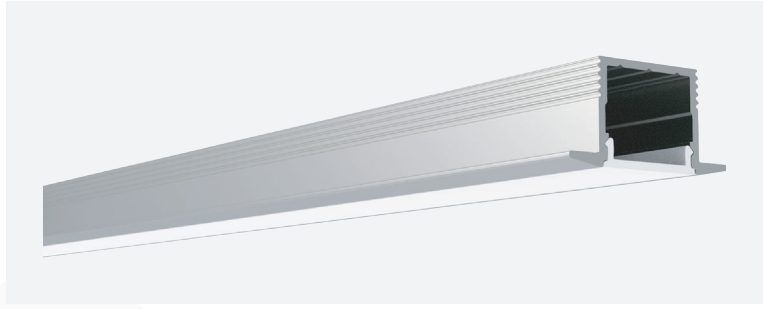

【Optical & electronic data】

Model	CCT	CRI	Input Voltage (V)	Max. Current (A/m)	Type Power (W/m)	Max. Power (W/m)	Lumen (LM/m)	Length	Note
ALS-BE2513FDXSS1000-F7NW9X-DC	2700K	>90	24	0.275 (0.08A/ft)	6.6 (2.01W/ft)	7.2 (2.2W/ft)	304.7 (92.9LM/ft)	1000mm (3.28ft)	7LEDs/50mm
	3000K						316.3 (96.4LM/ft)		
	4000K						327.8 (101LM/ft)		
	6000K						316.3 (96.4LM/ft)		

Note:

1. The above parameters were tested based on 1M standard products;
2. luminous flux is allowed to have a $\pm 10\%$ error range;
3. The above parameters are typical values.

[Optical Parameter]

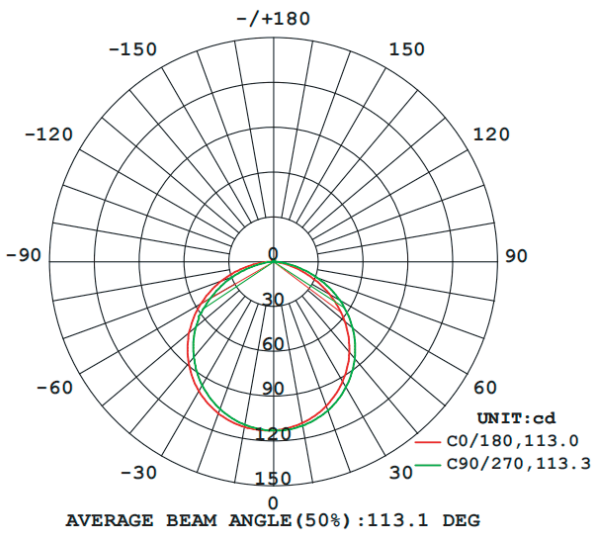

Flux out:242.0 lm

1m	32.49,113.21x	302.05cm
2m	8.123,28.291x	604.10cm
3m	3.610,12.571x	906.15cm
4m	2.031,7.0731x	1208.20cm
5m	1.300,4.5271x	1510.25cm
6m	0.9025,3.1441x	1812.30cm
7m	0.6631,2.3101x	2114.35cm
8m	0.5077,1.7681x	2416.40cm
9m	0.4011,1.3971x	2718.45cm
10m	0.3249,1.1321x	3020.50cm

Height Eavg,Emax Angle:112.98deg Diameter
 Note:The Curves indicate the illuminated area and the average illumination when the luminaire is at different distance.

[Product mechanical data]

· Straight wire outlet

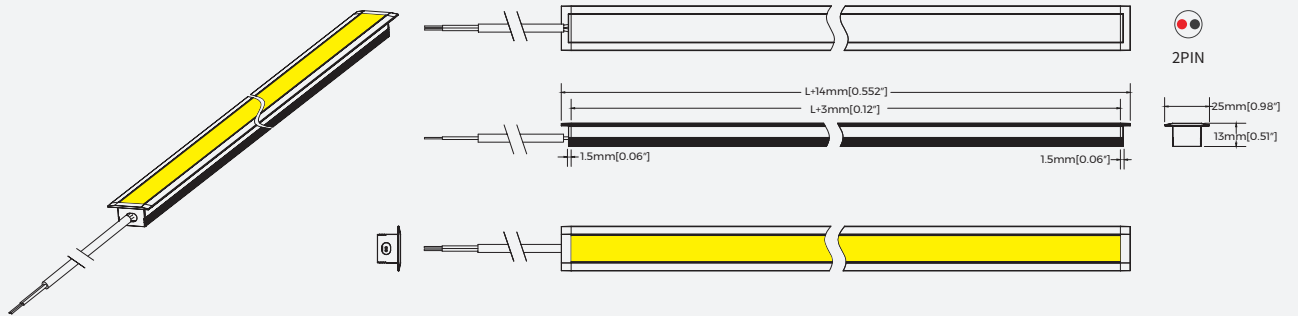



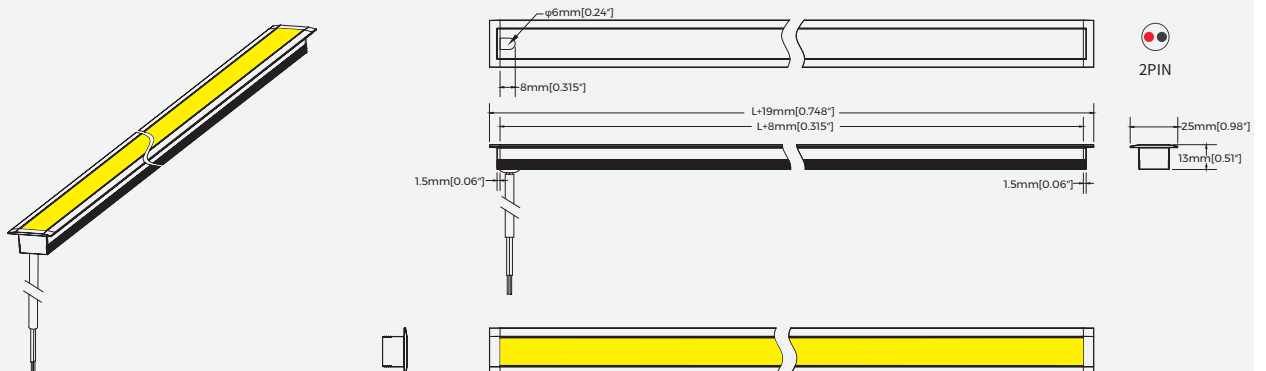



· Bottom wire outlet

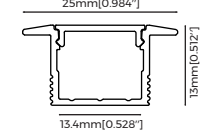

[Application]

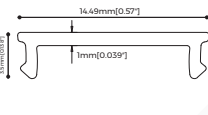
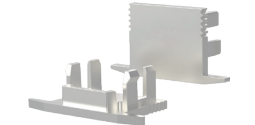
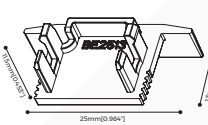
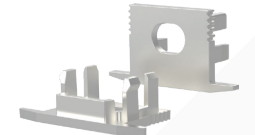
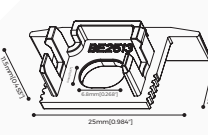

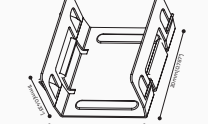
[Product Accessories Information]

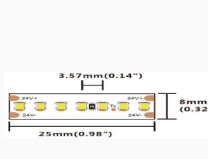
Picture	Section size	Name	Description	Model	Note
		Profile	Material: AL6063-T5 Surface processing: Anodizing Size: L2500*W25*H13mm [Inch size: L98.425**W0.984**H0.512"]	PR-BE2513S2500	
		Cover	Material: PC Light transmittance: >60% Size: L2500*W14.49*H3.5mm [Inch size: L98.425**W0.57**H0.138"] PC feature: The diffuser will extend (shrink) 0.8mm/m when the temperature raises (drops) 10°C.	CV-BE2513FD2500	
		End cap	Size: L25*W13*H11.5mm [Inch size: L0.984**W0.512**H0.453"]	EC-BE2513FSS	
		End cap with hole	Size: L25*W13*H11.5mm [Inch size: L0.984**W0.512**H0.453"] Hole size: 6.8*5mm [Hole inch size: 0.268**0.197"]	EC-BE2513FSD	
		Clip	Size: L21.79*W20*H11mm [Inch size: L0.858**W0.787**H0.433"]	CP-41	
		FPC strip	Material: FPC CCT: 2700/3000/4000/6000K; CRI > 90; Voltage: 24V; Power: 6.6W/m; Lumen: 710Lm/m; Width: 8mm; Minimum cutting unit: 50mm;	D6140-24V-8mm	

[Packing]

• Standard single-packed

1. Tightly twine and fix the magnetic end caps and profile with wrapping film to prevent plastic end caps from displacement and crush, and sheathe the luminaire with PE tube.



2. Put the product upside down on 15mm thick poly-foam and stuff 22mm thick poly-foam at two ends, surround the sides with poly-foam and bundle it with wrapping film.



3. Then put it upside down onto a 3mm thick W9K box board, and fold the board to wrap the product.

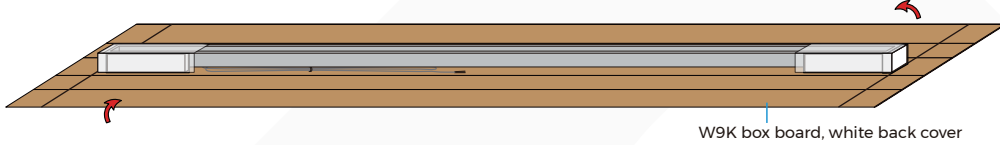

4. Seal the edge with tape and paste the product information label.



5. Place the packed white boxes in bundles as per standard quantity and requirements. Stuff the two ends with paper sheath and bundle them with wrapping film.

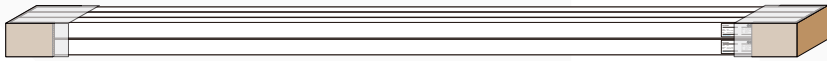

6. Place the bundled product on carton board with creasing cuts and wrap it.



7. Seal the carton and sheathe it with protective corners and wrapping film to finish the package.



8. Label and stamp QC and carton number seals (COLORS label, quantity, net and gross weight label)

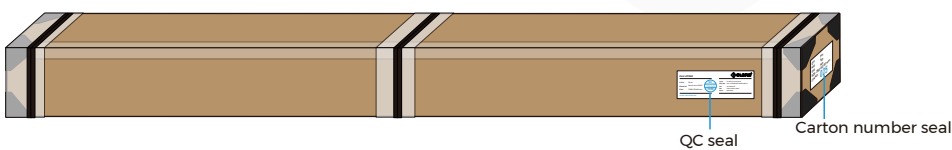

[Packing]

• Standard carton-packed

1. Stuff 0.7mm thick poly-foam in between profiles, several pieces a layer, a layer a bundle.



2. Place the bundles onto carton board as per specified number and layers.



3. Wrap paper sheath around both ends, fill 30mm thick poly-foam into the sheath, and bundle it with wrapping film.



4. Place the bundled product on carton board with creasing cuts and wrap it, then seal with wide tape.



5. If many profiles to be packed, bundle the above each four packed bundles together and sheathe them with two L-shaped protective corners (bend-proof), twine with wrapping film and label.

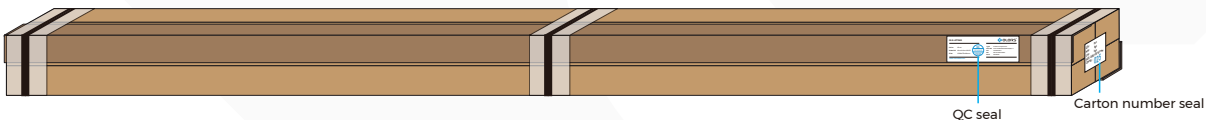

If a few profiles to be packed, directly sheathe the packed bundle with two L-shaped protective corners (bend-proof), twine with wrapping film and label.



Model	Demension	Quantity /box	Quantity /carton	NW (kg)	NW /carton/ (kg)	GW (kg)	Carton size
ALS-BE2513FDXSS2500-DC	/	/	/	/	/	/	/
ALS-BE2513FDXSS2500-BC	/	/	/	/	/	/	

[Attentions]

- 1、 Non-professionals are prohibited from installing, disassembling and repairing the product.
- 2、 Avoid scratching, distortion and irregular bending of the product during installation; otherwise it may cause irreparable damage to the product.
- 3、 Please use professional cutting tools when cutting
- 4、 Do not use any acid or alkaline adhesive to fix products
- 5、 The product is only suitable for indoor dry places, can not be used in outdoor, seaside or wet environment.
- 6、 PC features: Each 10°C rise or drop will make diffuser extend or shrink 0.8mm/m, please confirm before processing and use