

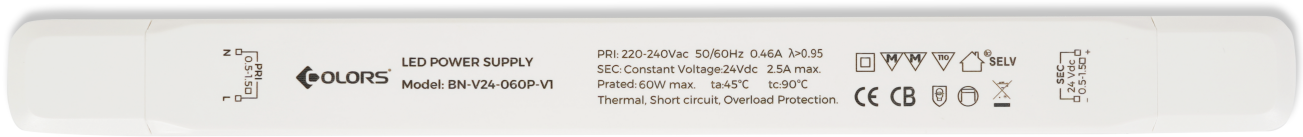



BN-V1 Constant Voltage Power Supply Specifications





Directory

1. Features and Applications	1
2. Electrical Parameters	2
3. Test Data	3
4. Directions for Use	4
5. Dimensions and Packing	5





LED POWER SUPPLY
 Model: BN-V24-060P-V1

PRI: 220-240Vac 50/60Hz 0.46A $\lambda > 0.95$
 SEC Constant Voltage: 24Vdc 2.5A max.
 Rated: 60W max. $t_a: 45^\circ\text{C}$ $t_c: 90^\circ\text{C}$
 Thermal, Short circuit, Overload Protection.





Features

1. 220-240VAC input, constant voltage DC24V output.
2. ClassII power supply, no strobe.
3. Built-in active power factor correction circuit, high PF, low THD.
4. Quick start, power on start time is less than 0.5 seconds.
5. Small size, high efficiency, strong reliability and long service life.
6. -20°C - $+50^\circ\text{C}$ normal work, 100% full load aging test.
7. Short circuit protection, over temperature protection, overload protection, over voltage protection.
8. CE, CB certification.
9. Five years warranty.

Applications

1. LED indoor lighting
2. LED office lighting
3. LED commercial lighting
4. LED strip and neon products

Model Coding Rules

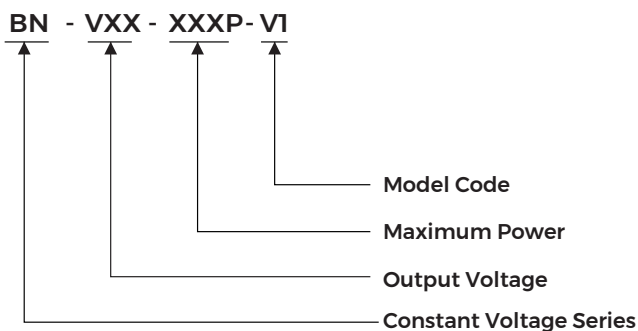

Electrical Specification

Model List	BN-V24-030P-V1	BN-V24-060P-V1	BN-V24-100P-V1
Input			
Rated Input Voltage	220-240VAC	220-240VAC	220-240VAC
Range Of Input Voltage	198-264VAC	198-264VAC	198-264VAC
Range Of Input Voltage(VDC)	176-250VDC	176-250VDC	176-250VDC
Frequency(Hz)	0/50/60 Hz	0/50/60 Hz	0/50/60 Hz
Power Factor	>0.95 @Full load, 230VAC	>0.95 @Full load, 230VAC	>0.95 @Full load, 230VAC
Input Current max	0.24A MAX. @Full Load,198VAC	0.46A MAX. @Full Load,198VAC	0.78A MAX. @Full Load,198VAC
Start-up Time	<0.5S	<0.5S	<0.5S
Unload Power Consumption	≤0.5W	≤0.5W	≤0.5W
Inrush Current	≤20A @Full load, 230VAC	≤50A @Full load, 230VAC	≤60A @Full load, 230VAC
THD	<8% @Full load, 230VAC	<8% @Full load, 230VAC	<8% @Full load, 230VAC
Leakage Current	<0.7mA(240VAC)	<0.7mA(240VAC)	<0.7mA(240VAC)
Output			
Constant Voltage	24VDC	24VDC	24VDC
Current Range	0-1.25A	0-2.5A	0-4.17A
Rated Power	30W	60W	100W
Voltage Accuracy	±5%	±5%	±5%
Voltage Regulation	±1% @Full Load	±1% @Full Load	±1% @Full Load
Load Regulation	±2%	±2%	±2%
Ripple & Noise *Note.2	≤±2% @Full load, 230VAC	≤±2% @Full load, 230VAC	≤±2% @Full load, 230VAC
Output LF Current Ripple	≤±1%	≤±1%	≤±1%
Efficiency(Typ.)	≥85% @Full load, 230VAC	≥89% @Full load, 230VAC	≥91% @Full load, 230VAC
Protection			
Over Load Protection	Protection Type: Auto Resume		
Short Circuit Protection	Protection Type: Auto Resume		
Over Temperature Protection	Protection Type: Auto Resume		
Environment			
Operating Temperature	-20℃...+45℃		
Tc	85℃	90℃	85℃
Storage Temperature	-40℃...+60℃		
Life Time	>50,000h @Full load, 230VAC, ta=45℃		
Temperature Coefficient	±0.03%/℃(0-45℃)		
Humidity	20%-90%RH		
IP Rating	IP20		
Safety & EMC			
Isolation Resistance	EN61347-1; EN61347-2-13; EN62493; EN62384		
Withstand Voltage	Input-Output: 3750V/5mA/1min		
Isolation Resistance	Input-Output: ≥4MΩ @500VDC		
EMI	EN55015; EN61000-3-2 Class C; EN61000-3-3		
EMS	EN61547; EN61000-4-2;		
Certificate	CE, CB, SELV		
Others			
Dimension	261X30X17mm(L*W*H)	329X30X17mm(L*W*H)	365X30X18mm(L*W*H)

Remarks:

- 1.All Parameters, if not specified, are measured at 230VAC/50Hz and 25℃ ambient temperature.
- 2.LED Driver is a component of the luminaires, Luminaires and wire layout will affect the EMC, please check the EMC with end products again.

Model List

Model	Input			Output		
	Input Voltage	Input Current	Frequency	Output Voltage	Output Current	Output Power
BN-V24-030P-V1	220-240VAC	0.24A	50/60Hz	24V	0-1.25A	30W
BN-V24-060P-V1	220-240VAC	0.46A	50/60Hz	24V	0-2.5A	60W
BN-V24-100P-V1	220-240VAC	0.78A	50/60Hz	24V	0-4.17A	100W

Electrical Values(BN-V24-030P-V1)

Lifetime vs. Ambient Temperature Curve

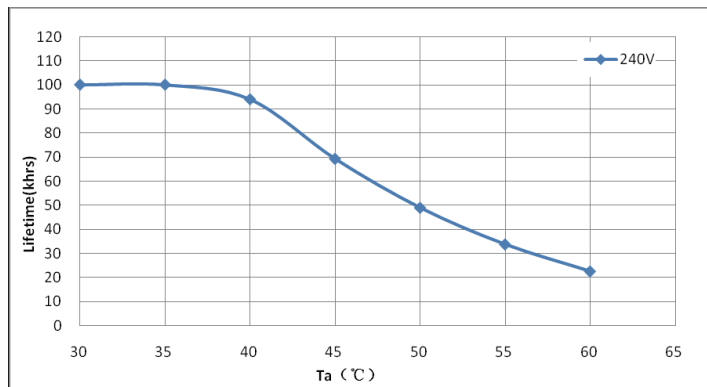

Efficiency vs. Load

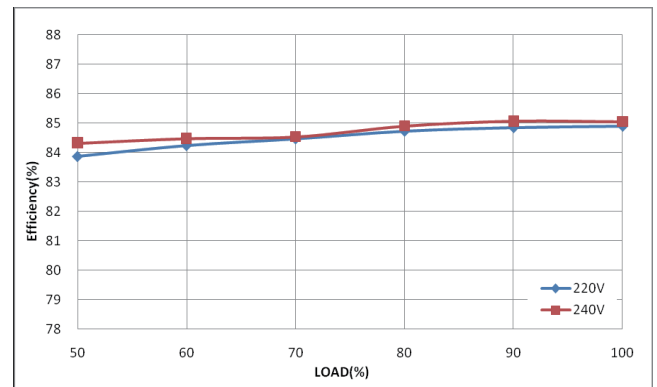

Power Factor Characteristics

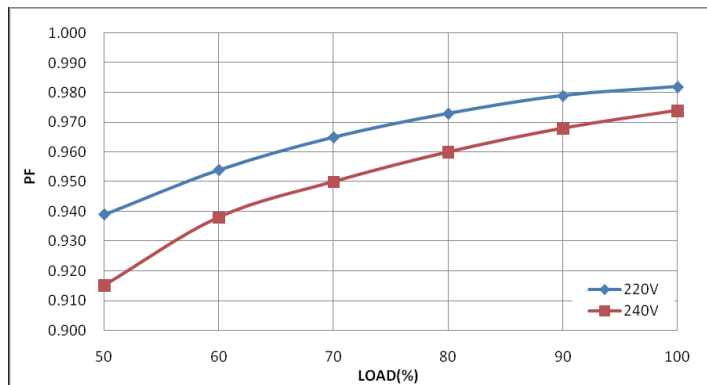

THD vs. Load

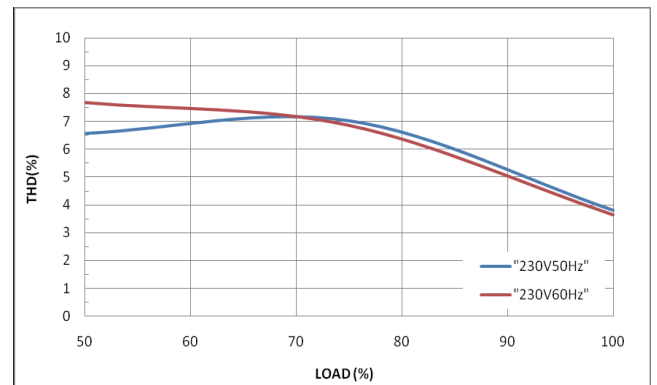

Product Label

BN-V24-030P-V1

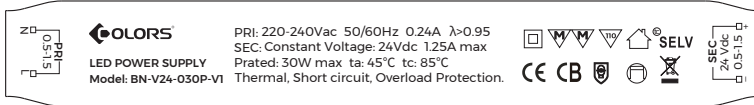

BN-V24-060P-V1

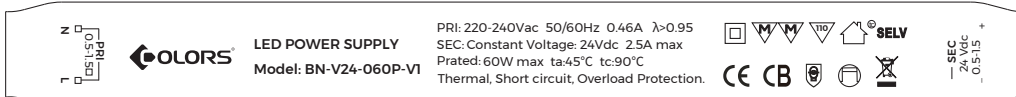

BN-V24-100P-V1

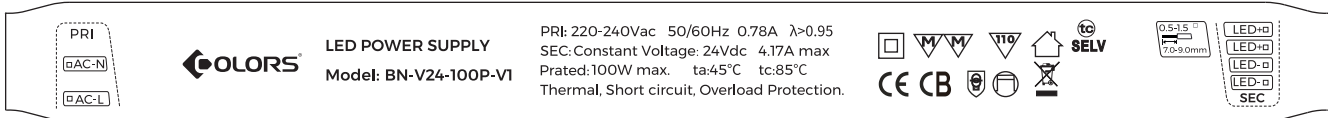

Wiring Diagram

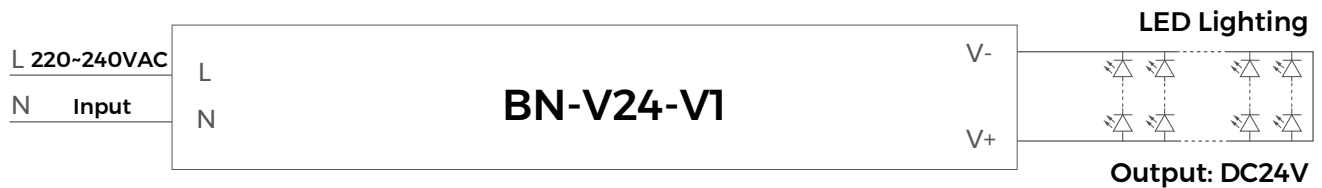

Cautions

1. The product shall be installed and serviced by a qualified person.
2. This product is non-waterproof. Please avoid the sun and rain. When installed outdoors please ensure it is mounted in a water proof enclosure.
3. Good heat dissipation will prolong the working life of the controller. Please ensure good ventilation.
4. Please check if the output voltage and current of any LED power supplies used comply with the requirement of the product.
5. Please ensure that adequate sized cable is used from the controller to the LED lights to carry the current. Please also ensure that the cable is secured tightly in the connector.
6. For safety consideration, PVC or rubber cord of 0.75-1.5mm² is recommended for input and output terminal(s) .Flat power cord is not suitable. Ensure all wire connections and polarities are correct before applying power to avoid any damages to the LED lights.
7. The power supply should be strictly and reliably grounded to prevent electric shock.
8. If a fault occurs please return the product to your supplier. Do not attempt to fix this product by yourself.

Mechanical Dimensions

BN-V24-030P-V1

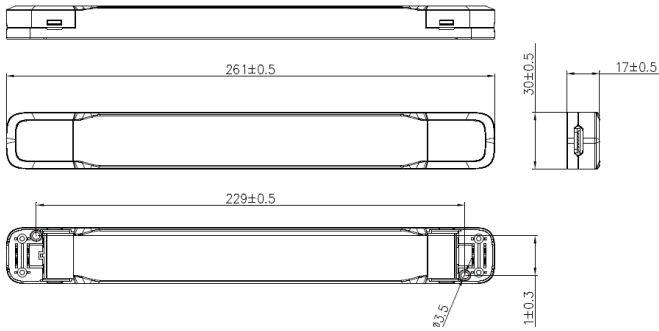

BN-V24-060P-V1

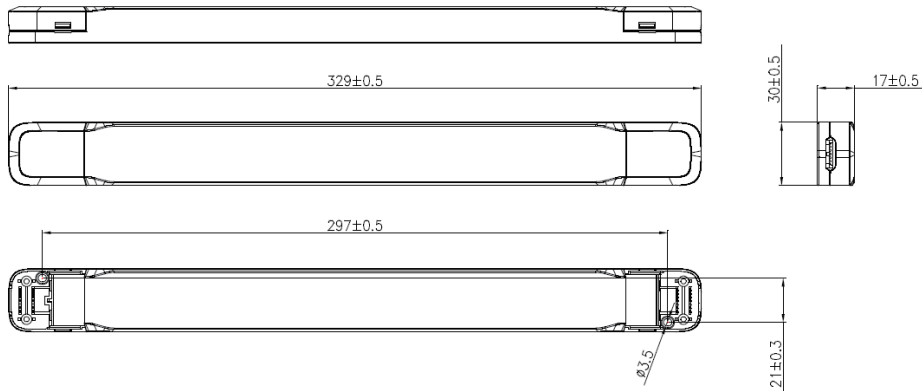

BN-V24-100P-V1

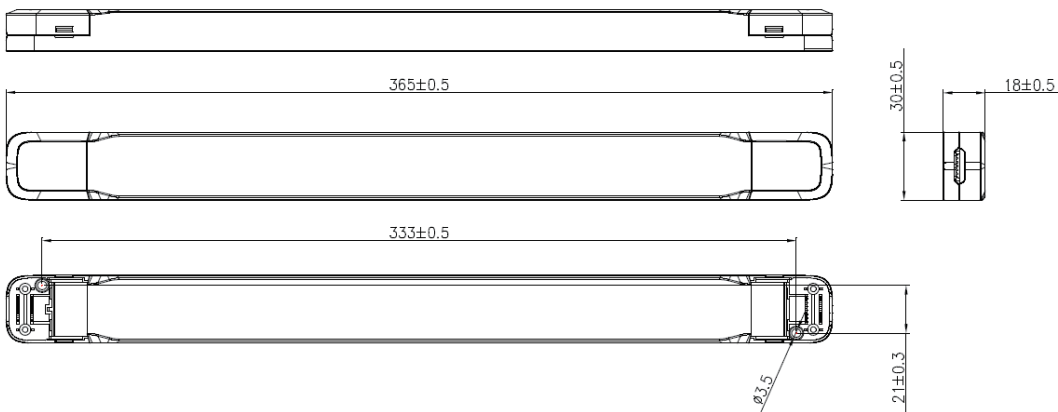

Packing

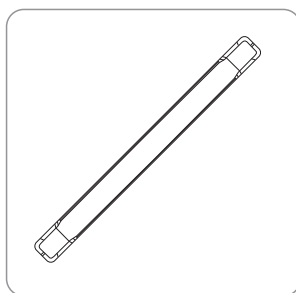

Product

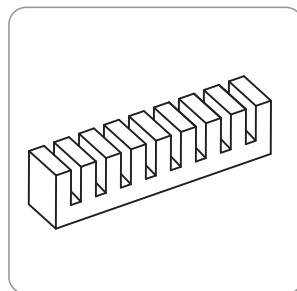

Pearl Wool

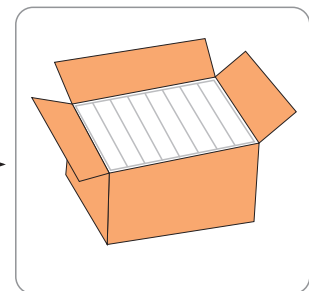

Carton