

Specification

ECO series
DJ120-24V-8mm



▼ General description

- Reel without soldering joint, high cost effective
- cUL/CE certificated
- 3 years warranty
- IP20/IP55/IP65 applied



▼ Dimension

Max.length: 5000mm(196.85")

Cutting unit: 6leds/50mm(1.97")

LED pitch: 8.33mm(0.33")

Min. bend diameter: Φ 60mm(2.36inch)

Mounting: 3M tape

IP: IP20/IP55/IP65

Warranty: 3years

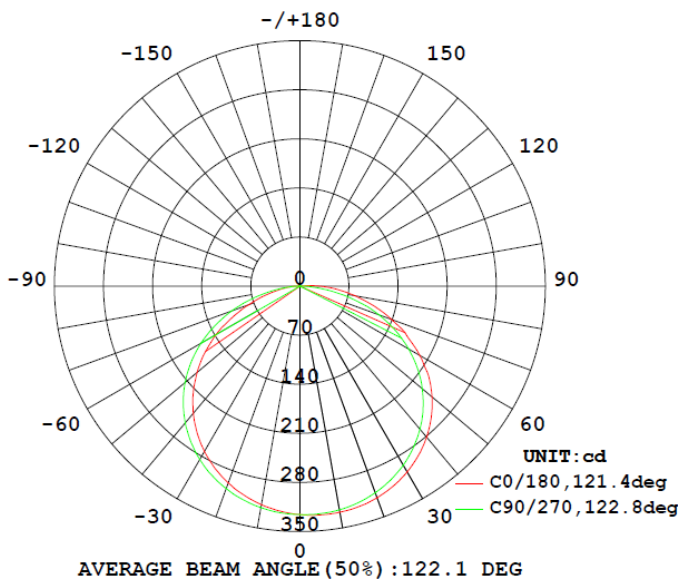
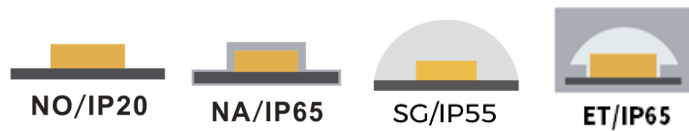
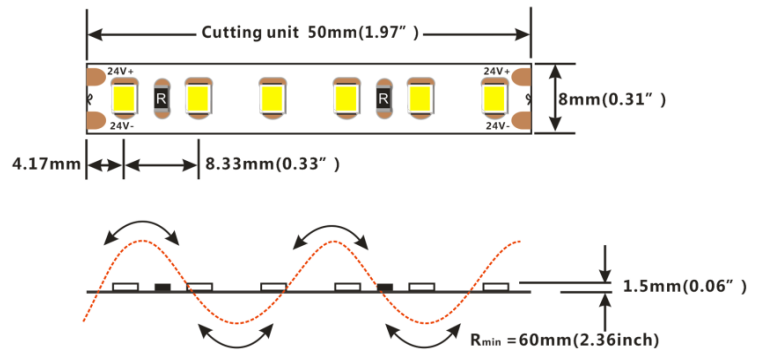

Photometric of 1M strip

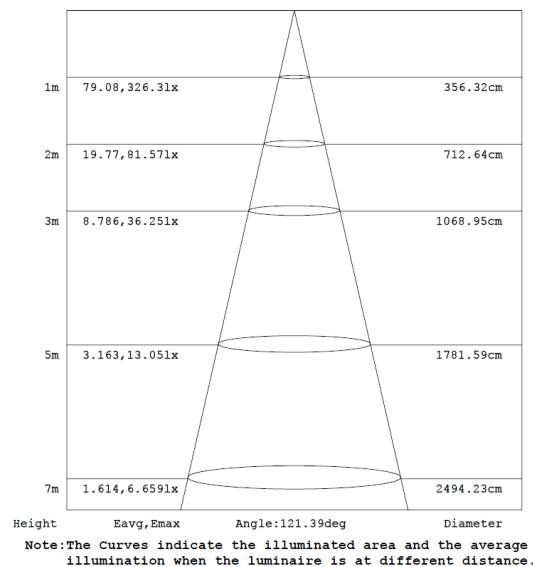

AAI Figure

※Max.length data is based on 10% voltage drop

※Warranty is based on indoor use

▼ Electronic & output data

Input voltage: DC24V

Rated current: 0.37A(1m) /1.79A(5m)

Typical Powe: 8.8W(1m)(2.68W/FT) /43W(5m)

CRI: 80

Max.power: 9.6W(2.93W/FT)

On-off times: 10000 (test times)

Power range: 8 ~ 9.6W

Copper foil: 2oz



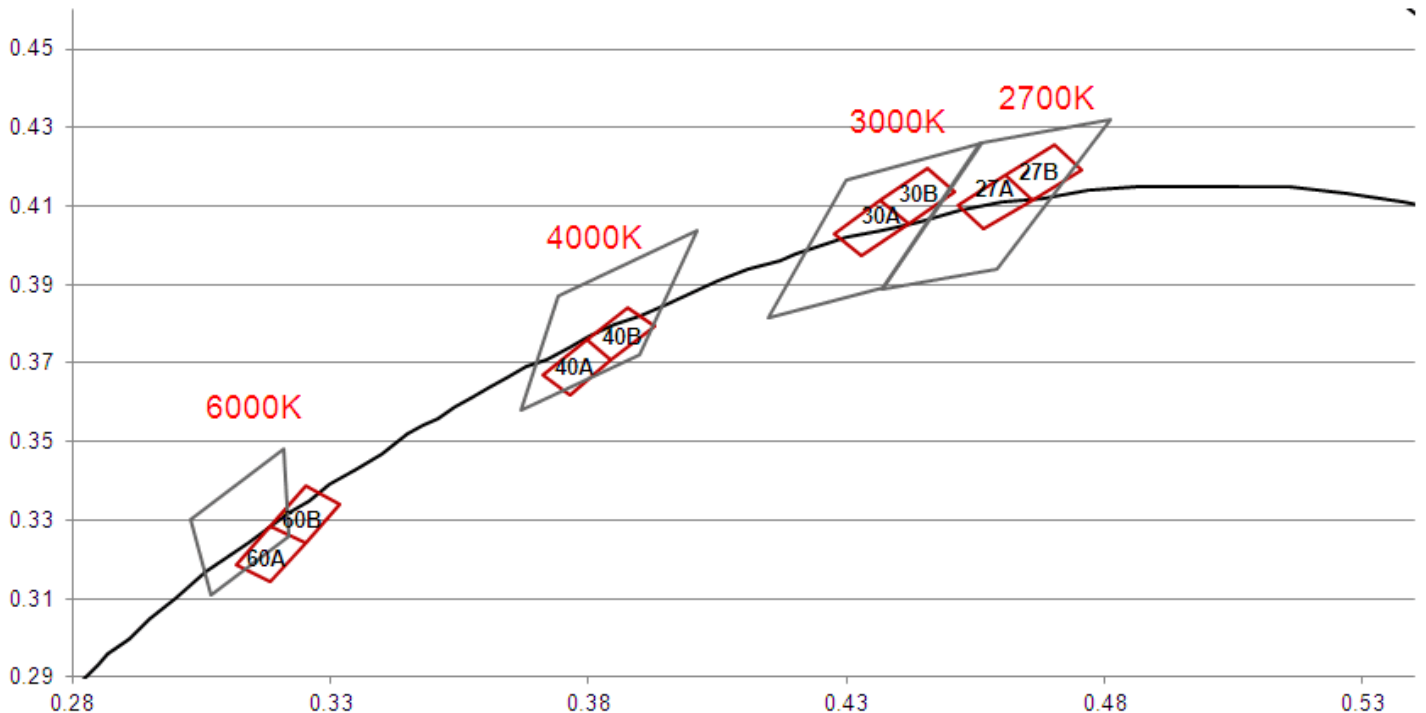

CRI	Color	CCT	Lumen(lm)	lm/W	Energy efficiency class
Ra>80	SW	2700K	900	93	F
Ra>80	WW	3000K	960	100	F
Ra>80	NW	4000K	1040	112	F
Ra>80	W	6000K	1000	104	F

- 1.The tolerance of output data can be vary up to 15%
- 2.the output data tested according to IES TM-30-15
- 3.the output data is based on IP20/1merter, data of 5m in only for reference
- 4.IP protection process leads changes to size, CCT and luminous flux











▼ BIN



▼ IP Process

IP Process	Picture	description	Size	optional CCT/color for finished product	lumen output rate
NO		No proof	8mm*1.5mm	2700K, 3000K 4000K, 6000K	100%
NA		Nano-proof	8mm*1.5mm	2700K, 3000K 4000K, 6000K	98%
SG		Gel coating	8mm*2.7mm	3300K, 3800K, 5900K, 15000K	90%
ET		Extrusion tube	10mm*4.8mm	2700K, 3000K 4000K, 6000K	88%

▼ Accessories Information

Name	Picture	Code	description
Slim connector		94-03-00-0065	TSC-08-2, suitable for 8mm fpc to fpc connection , IP20, 2pin, 10pcs per bag
FPC with wire		94-03-00-0066	wire connection when using together with TSC-08-2,IP20,2PIN, 10PCS per bag
Connector for wire and FPC		94-03-00-0044	8mm width, 2PIN connector of wire and FPC,suitable for white color and gel coating strip,SG,2PIN wire18-22AWG
Connector for FPC and FPC		94-03-00-0048	8mm width, 2PIN connector of FPC and FPC,suitable for white color and gel coating strip,SG
Fixed Clip		94-02-00-0002	Silicone clip,suitable for 8mm PFC
Fixed Clip		94-02-00-0015	Fixed clip, transparent, 3*8mm self-tapping screws,suitable for 8mm FPC,SG LED strip
Fixed Clip		94-02-00-0017	Fixed clip,8mm FPC.IP20,transparent, 3*8mm self-tapping screws
Hole plug		94-02-00-0021	Silicone end cap without hole,suitable for 8mm PFC, IP65 IP67 waterproof LED strip
Mounting groove		94-02-00-0024	Transparent PVC mounting groove,suitable for 8mm FPC,silicone extruded EF/ET strip
Stopper glue		94-16-03010001	Silicone gel,suitable for IP65 and IP67 LED strip

▼ Order Code Formats

1: Category		2: LED		3: LED/m		4: Voltage		5:FPC Width		6: IP Process		7: CRI		8: CCT	
D	-	J	2835J	120	120 LED	24	24V	08	8mm	NO	No proof	8	> 80	SW	2700K
										NA	Nano-proof			WW	3000K
										ET	Extrusion tube			NW	4000K
										SG	Gel coating			W	6000K
D		J		120		24		08		NO		8		SW	
9: Silk Printing		10: Entry cable		11: Wire type		12: Wire length		13: Tape type		14: Label Type		15: Strip Length			
N	Neutral	S	Single	A	red and black cable	012	12cm	W	White 3M	C	COLORS	0100	1m		
		D	Double	B	SM-male wire	020	20cm	Y	Yellow 3M	S	Customized	0500	5m		
		X	Nothing	C	SM-female wire	050	50cm	R	Red tape			5000	50m		
				X	Nothing	100	100cm	X	Nothing						
						0	Nothing								
N		S		A		012		W		C		0100			

DJ1202408NO-8SWNSA012WC0500

▼ Packing

Colors brand package

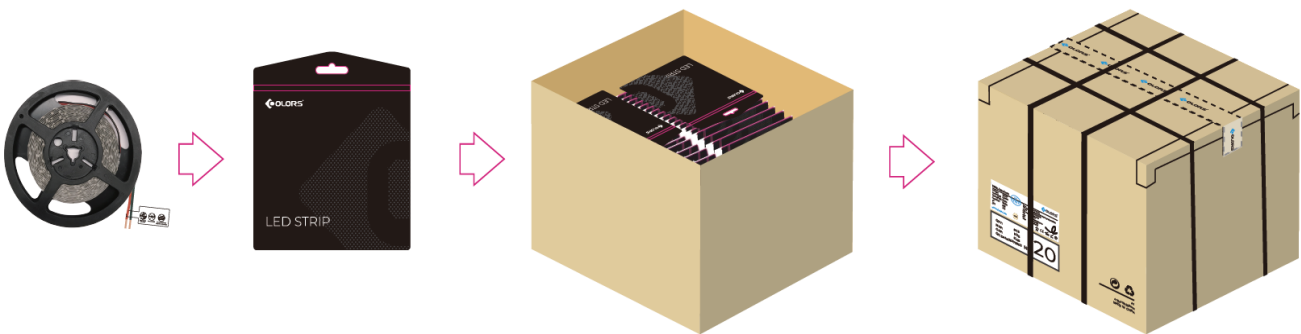

General customized package

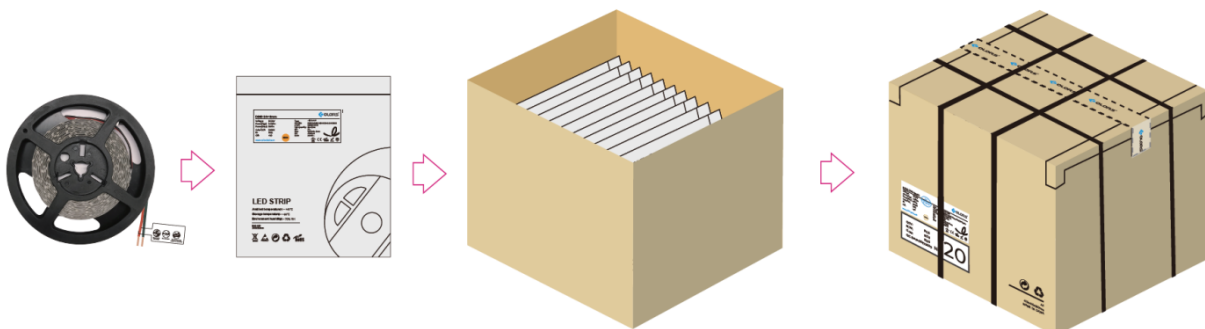

IP Process	Product size(mm)	Product quantity (m/reel)	Product quantity (m/case)	Product net weight(kg)	Net weight per box (kg)	Gross weight (kg)	Package size (mm)
NO (Cbp)	5000*8*1.5	5	350	0.08	5.6	6.25	365*365*190
NA (Cbp)	5000*8*1.5	5	350	0.085	6	6.65	365*365*190
NO (Gcp)	5000*8*1.5	5	300	0.11	6.6	7.6	410*410*260
NA (Gcp)	5000*8*1.5	5	300	0.115	6.9	7.935	410*410*260
SG	5000*8*2.7	5	300	0.168	10.08	12.1	410*410*260
ET	5000*10*4.8	5	200	0.42	16.9	19.3	410*410*260

Remark: data with 10% tolerance

Engineering packaging of ET(IP67)

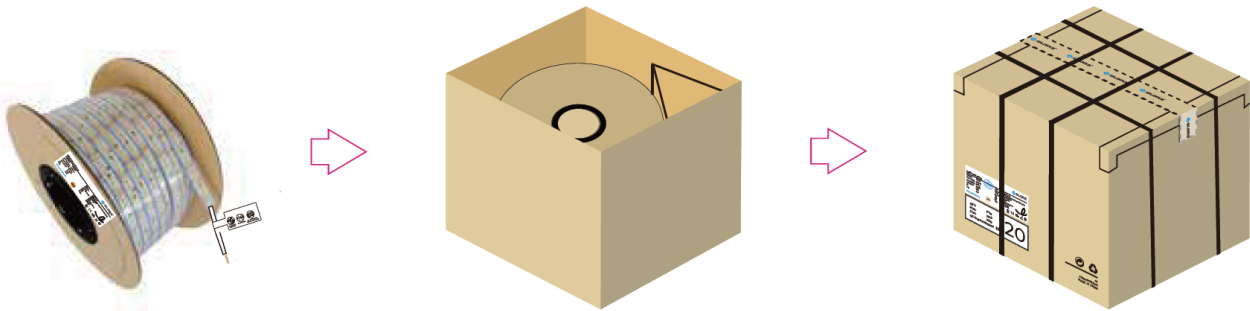

Engineering packaging of NO(IP20)/NA(IP65)

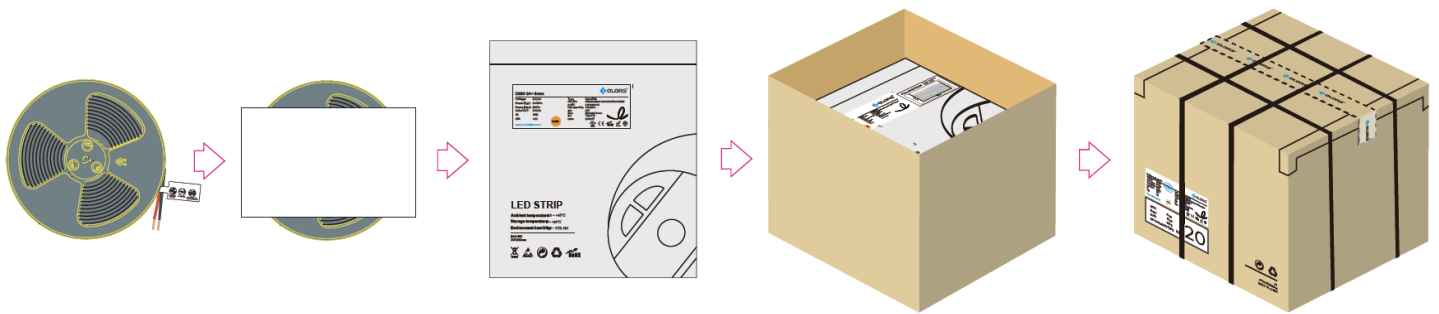

IP Process	Product size(mm)	Product quantity (m/reel)	Product quantity (m/case)	Product net weight(kg)	Net weight per box (kg)	Gross weight (kg)	Package size (mm)
NO	50000*8*1.5	50	650	0.92	12.1	13	410*410*260
NA	50000*8*1.5	50	650	0.97	12.6	13.6	410*410*260
ET	50000*10*4.8	50	100	4	8	8.5	255*255*260

Remark: data with 10% tolerance

▼ Precautions

- ※ Please drive the led strip with 24VDC isolated power, and the ripple of the constant voltage source should be less than 5%.
- ※ Please do not bend the strip into an arc with a diameter less than 60mm to ensure the longevity and reliability.
- ※ Do not fold it in case any damage of LED beads.
- ※ Do not pull the power wire hard to ensure the longevity. Any Crash may damage the LED light is prohibited.
- ※ Please make sure the wire is connected to the anode and cathode correctly. The power output should be consistent with the voltage of the strip to avoid damage.
- ※ LED lights should be stored in dry, sealed environment. Please only unpack it before usage. Ambient temperature: -25°C~40°C.Storage temperature: 0°C~60°C.Please use the strips without waterproof within indoor environment with humidity less than 70%.
- ※ Please be careful during operation. Do not touch the AC power supply in case of electric shock.
- ※ Please leave at least 20% power for the power supply during using to ensure there is enough power supply to drive the product.
- ※ Do not use any acid or alkaline adhesives to fix the product (e.g.: glass cement).