

PRODUCT DESCRIPTION

- Combines several functions:
 - lighting fixture
 - frame for a stretched ceiling
 - frame for a suspended ceiling made of plasterboard, etc.
- Compatible with standard fastenings for suspended ceilings
- The FOLED system opens new possibilities of interior design

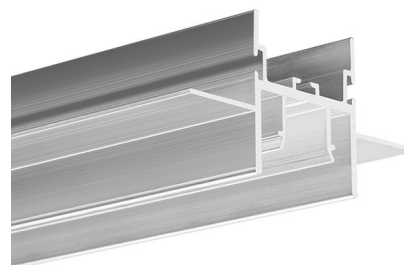

FINISH :

Non anodized (raw) 

*Custom colors available upon request

Fill empty fields

Product nr.	
Fixture type	
Company	
Job name	
Date	

TECHNICAL SPECIFICATION

Application

- for building ceilings employing the stretch-film technology with integrated LED lighting
- for building suspended ceilings with plasterboard
- the extrusion has a channel adapted to attach standard harpoons used in stretched surfaces

Assembly

- with the "FOLHAK" connectors and suspended ceiling hangers available on the market

Additional information

- intended for indoor and outdoor use
- profiles can be connected with each other at an angle over 60 degrees
- fixture is flush with the plane of the film
- easy connection using "ZM CONNECTORS"
- compatible with the whole FOLED profile family

AVAILABLE LENGTHS

Ref. nr.	surface finish	available lengths
B8332V1NA_1	Non anodized (raw)	1000 mm
B8332V1NA_2	Non anodized (raw)	2000 mm
B8332V1NA_3	Non anodized (raw)	3000 mm

TECHNICAL DRAWING

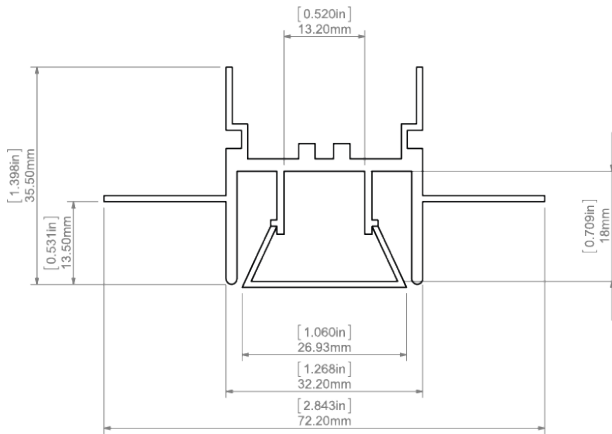

RELATED PROFILES

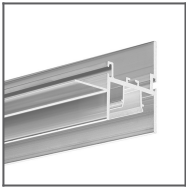

FOLED-BOK
profile
Ref: B8334V1

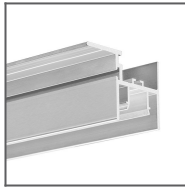

FOLED-SUF Profile
Ref: B8333V1

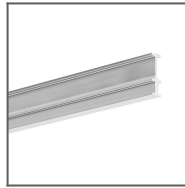

FOLHAK Profile
Ref: B8338

RELATED PRODUCTS

COVERS

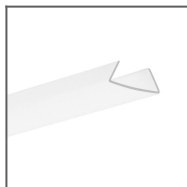

FOLED frosted Cover
Ref: 17077V1

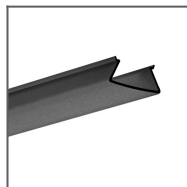

FOLED black Cover
Ref: 17045

80°

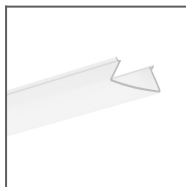

FOLED frosted Cover
Ref: 17047

100°



END CAPS



FOLED-W black End cap
Ref: 24285

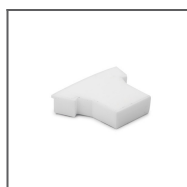

FOLED-W grey End cap
Ref: 24277

ACCESSORIES



8,8x1,2 Gland
Ref: 00802

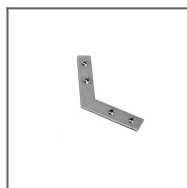

ZM-NA-120 Connector
Ref: 42729

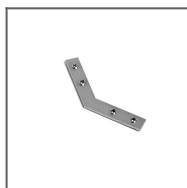

ZM-NA-135 Connector
Ref: 42725

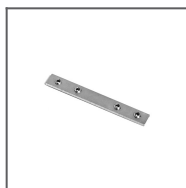

ZM-NA-180 Connector
Ref: 42724

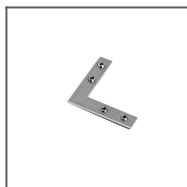

ZM-NA-90 Connector
Ref: 42723

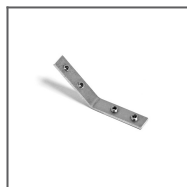

ZM-NA-PION-135 Connector
Ref: 42727

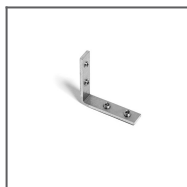

ZM-NA-PION-90 Connector
Ref: 42726

MARKETING MATERIALS



Display
P230-90111M
Ref: 90111M



Presentation set 7
Ref: 90126