

Profile MICRO-HG

Ref. A01419

Ref. arch C1419

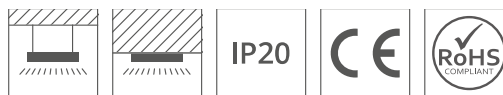
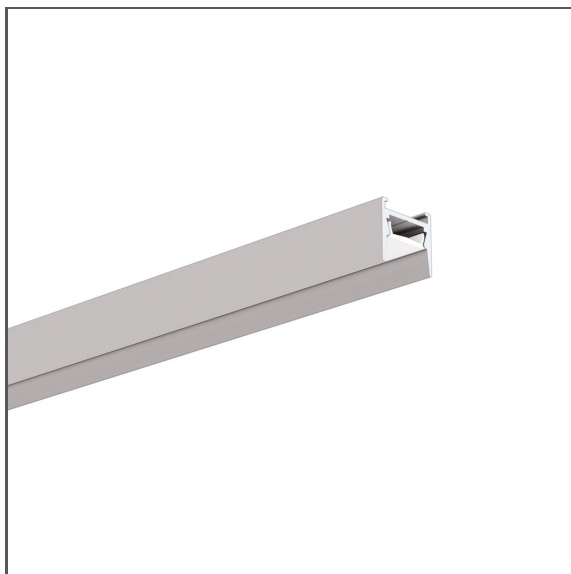

- Hidden light source
- Invisible mounting bracket
- Smooth profile walls

APPLICATION

- furniture and decorative lighting

MOUNTING

- to the surface or suspended, using dedicated accessories
- easy assembly and disassembly by snapping in and out

ADDITIONAL INFORMATION

- the installation of the cover in the recess reduces the effect of glare
- standard lengths of KLUŚ profiles and covers: 1000 mm (tolerance ± 1.5 mm) and 2005 mm / 3010 mm (tolerance + 5 mm); for selected covers: 6050 mm, 10050 mm (tolerance + 5 mm)
- when choosing a different length of profiles / covers than available in the standard, you should additionally choose the cutting service at KLUŚ

TECHNICAL DRAWING

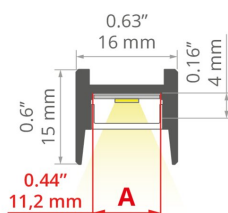

TECHNICAL SPECIFICATIONS

Material	aluminum
Possible fixture IP	20
Possible fixture shapes	rectangular
Profile cross-section	rectangular
Width	16 mm
Height	15 mm
LED gluing width A	11.2 mm
Number of LED strips A (8 mm wide)	1
Building type	Residential, Entertainment/ Arts, HoReCa object
Facility zone	office, kitchen, bathroom, furniture
Wire out back of extrusion	yes

Color	Length	Ref
■ silver anodized	1000 mm	A01419A_1 C1419ANODA_1
	2005 mm	A01419A_2 C1419ANODA_2
	3010 mm	A01419A_3 C1419ANODA_3
■ black anodized	1000 mm	A01419A07_1 C1419K7_1
	2005 mm	A01419A07_2 C1419K7_2
	3010 mm	A01419A07_3 C1419K7_3

Profile MICRO-HG

Ref. A01419

Ref. arch C1419

SAMPLE PROJECTS

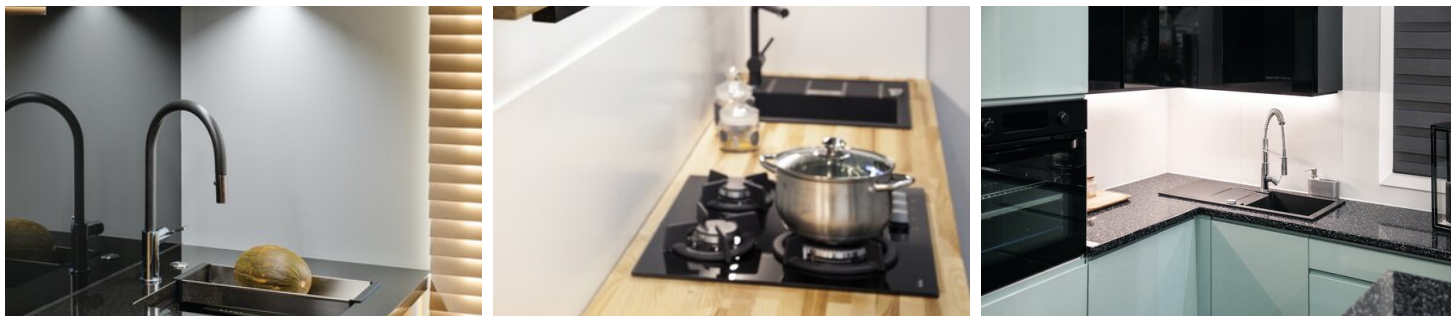

RELATED ACCESSORIES > RELATED COVERS

NAME	MATERIAL	MATERIAL TRANSMITTANCE	COLOR	REF.
LIGER		PC	70 % <input type="checkbox"/> frosted	B17037M 17037
			32 % <input checked="" type="checkbox"/> black	B17037C 17040
KA-COM		PVC	70 % <input type="checkbox"/> frosted	B17179M 17179
			93 % <input checked="" type="checkbox"/> clear	B17179T 17180
HS		PC	73 % <input type="checkbox"/> frosted	B17208M 1369
			94 % <input checked="" type="checkbox"/> clear	B17208T 1370
KA-PRO		PC	67 % <input type="checkbox"/> frosted	B17064M 17064
			94 % <input checked="" type="checkbox"/> clear	B17064T 17065
KA		PC	63 % <input type="checkbox"/> frosted	B17035M 17035
			91 % <input checked="" type="checkbox"/> clear	B17035T 17036

RELATED ACCESSORIES > RELATED END CAPS

NAME	MATERIAL	COLOR	REF.
MICRO-G		<input checked="" type="checkbox"/> gray	C24319C02 24319
		<input checked="" type="checkbox"/> black	C24319C07 24331

RELATED ACCESSORIES > RELATED LED

Profile MICRO-HG

Ref. A01419

Ref. arch C1419

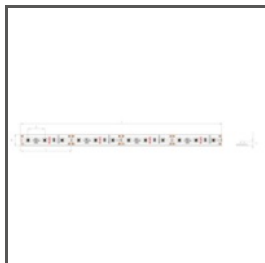

K-1210-12V
K-1210-12
Ref. arch K-1210-12V



K-1275-12V
K-1275-12
Ref. arch K-1275-12V



WP-K-1220-12V
KWP-1220-12
Ref. arch WP-K-1220-12V



WP-K-1275-12V
KWP-1275-12
Ref. arch WP-K-1275-12V



WP-K-1220-IP65-12V
_błąd
Ref. arch WP-K-1220-IP65-12V

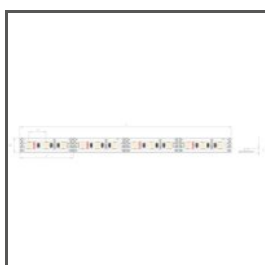

K-1275-RGB-12V
K-RGB-1275-12
Ref. arch K-1275-RGB-12V

RELATED ACCESSORIES > RELATED LED > CRI 95+



WP-K-CR-1210-24V
KWP-CR-1210-24
Ref. arch WP-K-CR-1210-24V



WP-K-CR-1220-24V
KWP-CR-1220-24
Ref. arch WP-K-CR-1220-24V

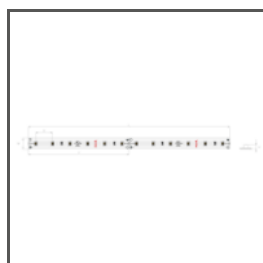

K-CR-1210-24V
K-CR-1210-24
Ref. arch K-CR-1210-24V



K-CR-1220-24V
K-CR-1220-24
Ref. arch K-CR-1220-24V

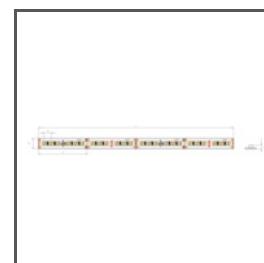

K-CR-1275-24V
K-CR-1275-24
Ref. arch K-CR-1275-24V

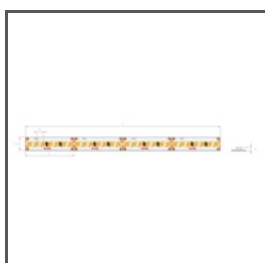

K-CR-1820-HD-24V
K-CRHD-1820-24
Ref. arch K-CR-1820-HD-24V



K-CR-1910-HD-24V
K-CRHD-1910-24
Ref. arch K-CR-1910-HD-24V

RELATED ACCESSORIES > RELATED LED > HIGH EFFICACY

Profile MICRO-HG

Ref. A01419

Ref. arch C1419

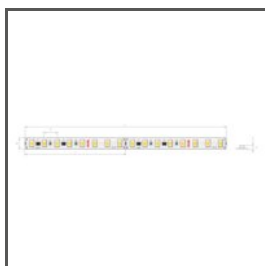

K-HE-0480-HD-24V

K-HEHD-0480-24

Ref. arch K-HE-0480-HD-24V

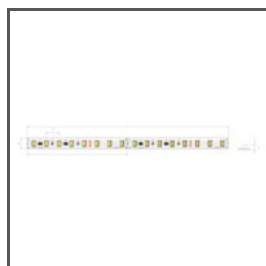

K-HE-0960-HD-24V

K-HEHD-0960-24

Ref. arch K-HE-0960-HD-24V

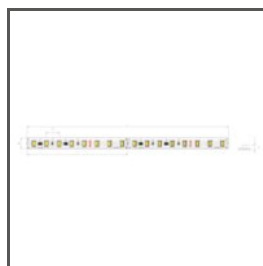

K-HE-1440-HD-24V

K-HEHD-1440-24

Ref. arch K-HE-1440-HD-24V

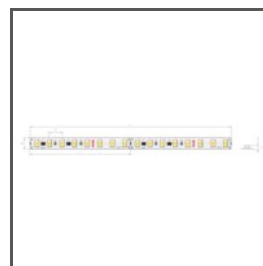

K-HE-1920-HD-24V

K-HEHD-1920-24

Ref. arch K-HE-1920-HD-24V

RELATED ACCESSORIES > RELATED LED > RGB / RGB-W / RGB-CTT



K-1530-RGB+W-24V

K-RGBW-1530-24

Ref. arch K-1530-RGB+W-24V

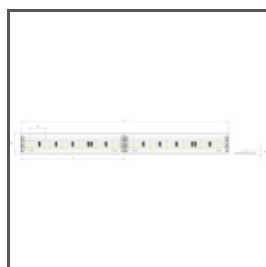

K-1920-120-RGB-24V

K-RGB-1920-120-24

Ref. arch K-1920-120-RGB-24V

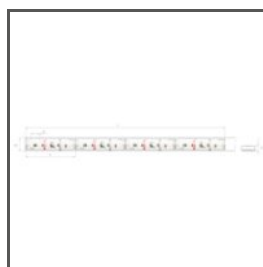

WP-K-1920-120-RGB-24V

KWP-1920-120-RGB-24

Ref. arch WP-K-1920-120-RGB-24V

RELATED ACCESSORIES > RELATED LED > WHITE MONO



WP-K-1640-HD-IP65-24V

KWP-GHD-1640-24

Ref. arch WP-K-1640-HD-IP65-24V



WP-K-1910-HD-IP65-24V

KWP-GHD-1910-24

Ref. arch WP-K-1910HDIP6524V



WP-K-1220-IP65-24V

KWP-1220-IP65-24

Ref. arch WP-K-1220-IP65-24V

RELATED ACCESSORIES > OTHER RELATED ACCESSORIES > ADDITIONAL ITEMS



BLOCK

H

C24366N00

Ref. arch 24366

RELATED ACCESSORIES > OTHER RELATED ACCESSORIES > CONDUCTIVE FASTENERS AND HEADS FOR PROFILES



FASTENER

FI-8-LIN-MR

C28172N00, C28172L10,
C28172L07

Ref. arch 42287, 42287L9010,
42287L9005



FASTENER

PUSZ-LIN-MR

C28163N00, C28163L10,
C28163L07

Ref. arch 42278, 42278L9010,
42278L9005



FASTENER

PUSZ-PRET-MR

C28166N00, C28166L10,
C28166L07

Ref. arch 42281, 42281L9010,
42281L9005

RELATED ACCESSORIES > OTHER RELATED ACCESSORIES > FASTENERS AND HEADS FOR PROFILES



HEAD

BZP

C28113N00

Ref. arch 42213

RELATED ACCESSORIES > OTHER RELATED ACCESSORIES > MOUNTING BRACKETS



MOUNTING BRACKET

PDS-H

C24214C02

Ref. arch 24214

RELATED ACCESSORIES > OTHER RELATED ACCESSORIES > OTHER

Profile MICRO-HG

Ref. A01419

Ref. arch C1419



GLAND

6x1,2

C24517C07

Ref. arch 00802

RELATED ACCESSORIES > OTHER RELATED ACCESSORIES > SECURITY AND BLOCKS

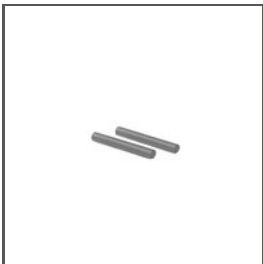

BLOCK

ZM

C28194N00

Ref. arch 42520

RELATED ACCESSORIES > OTHER RELATED ACCESSORIES > SUSPENSION AND MOUNTING SETS



FASTENER SET

W1

C28203N00

Ref. arch 42602



FASTENER SET

W2

C28204N00

Ref. arch 42603



FASTENER SET

W6

C28205N00

Ref. arch 42604



FASTENER SET

RG-1

C28230P00, C28230P01,
C28230L10, C28230L07

Ref. arch 42647Ni, 42647GSS,
42647L9010, 42647L9005