

RF Single Color Remote Controller

09.289SD.04166



Important: Read All Instructions Prior to Installation

Function introduction

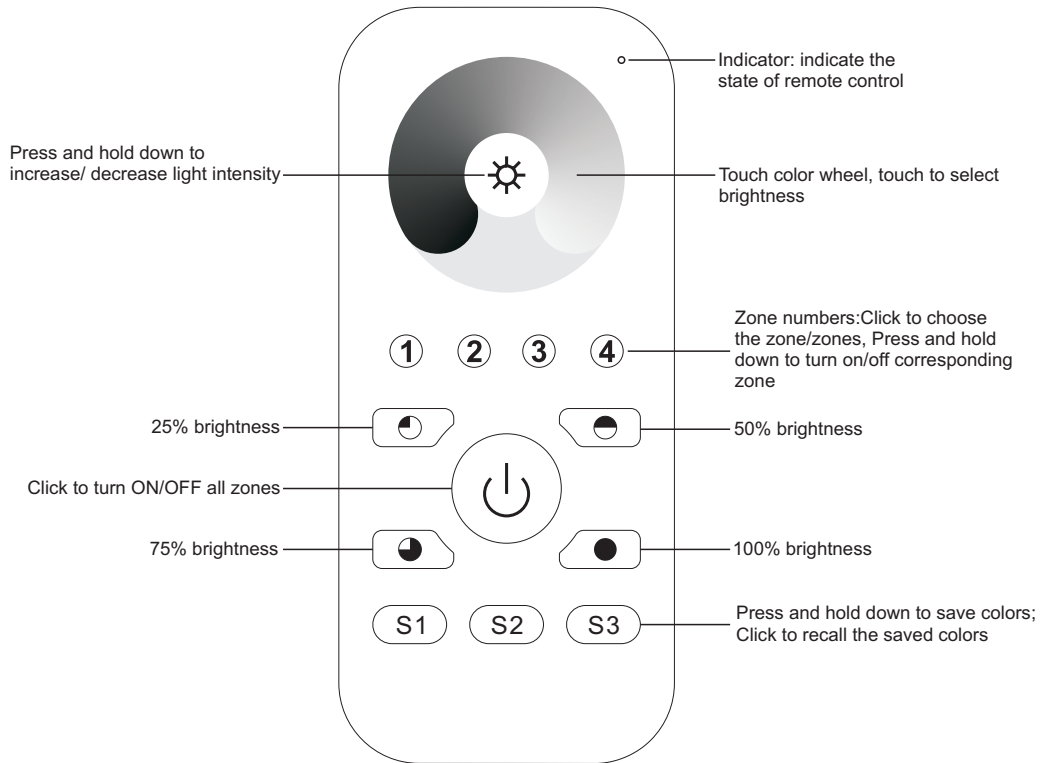

Front side

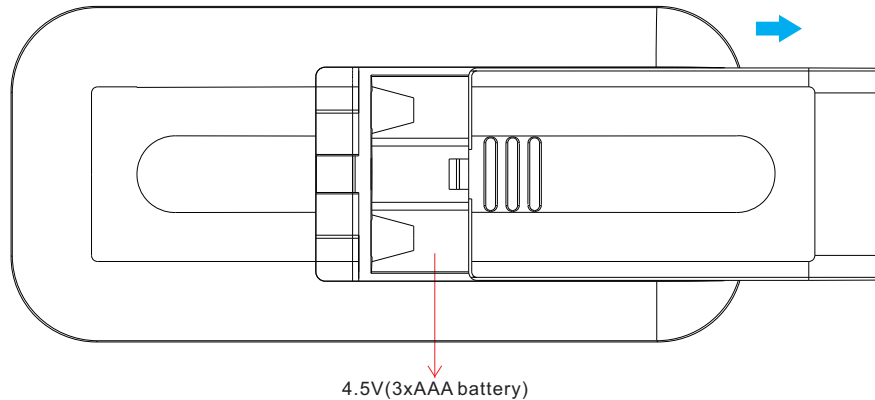

Bottom side

Product Data

Output	RF signal
Operation Frequency	869.5/916.5/434MHz
Power Supply	4.5V(3xAAA battery)
Operating temperature	0-40°C
Relative humidity	8% to 80%
Dimensions	120x55x17mm

- Control 4 zones of RF receivers separately.
- Single color controller
- High sensitive & high stable, fast & precise color control.
- Compatible with all universal series RF receivers
- 1 receiver can be paired by max 8 different remote controls.
- Waterproof grade: IP20

Safety & Warnings

- This device contains AAA batteries that shall be stored and disposed properly.
- DO NOT expose the device to moisture.

Pair with RF receiver(Method 1)

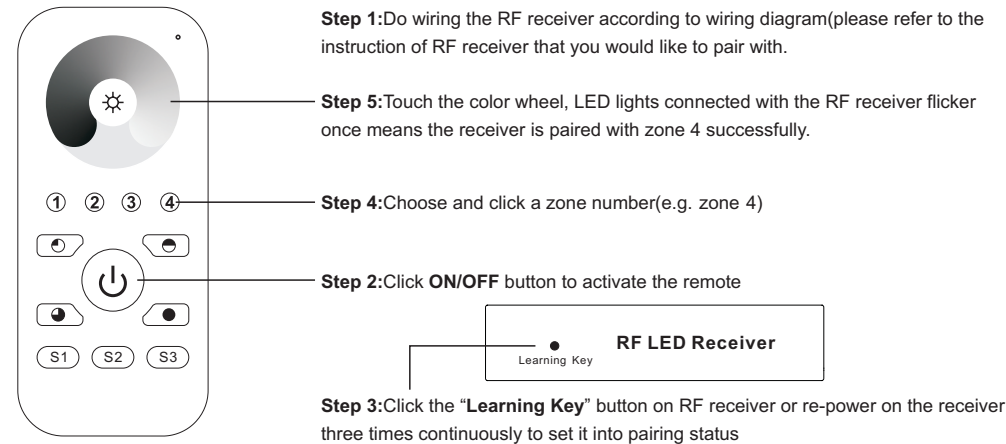

Pair with RF receiver(Method 2)

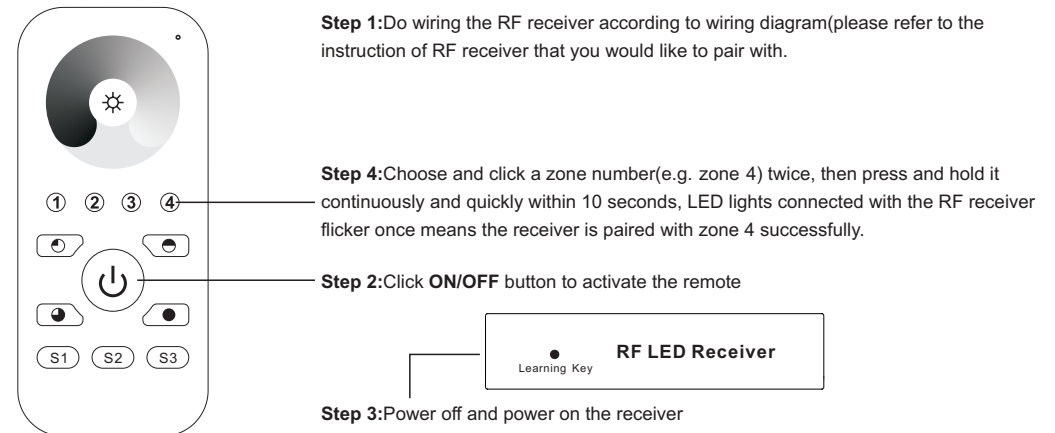

Save color/scene/mode

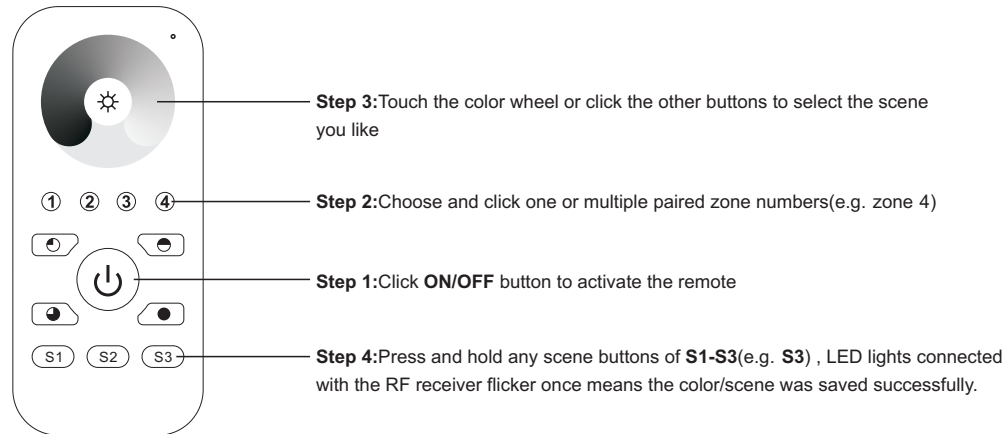

Recall the saved colors/scenes

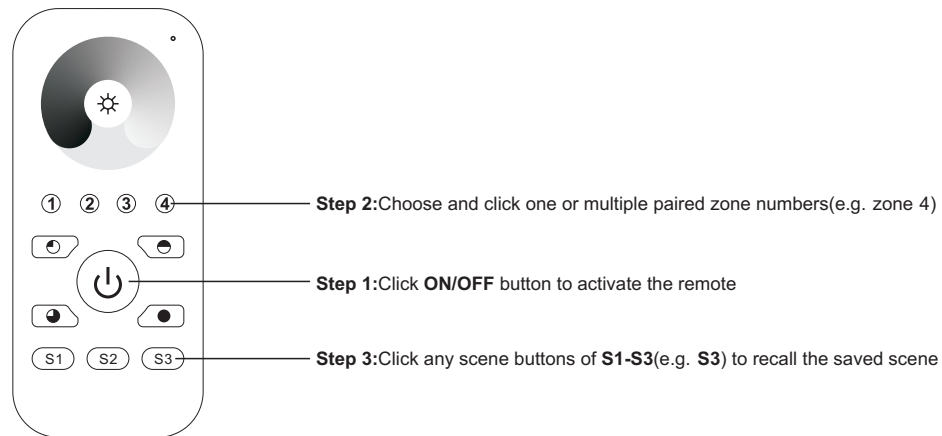

If you use multiple receivers, you have two choices:

Option 1: have all the receivers in the same zone, like zone 1

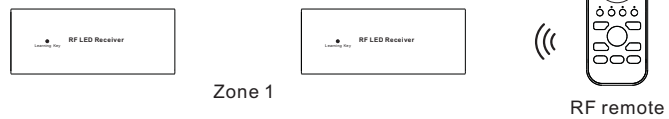

Option 2: have each receiver in a different zone, like zone 1, 2, 3 or 4

